

HIGH-PERFORMANCE 19" FAN TRAY

LE 019



- > High air output
- > Long service life
- > Ball bearing fans
- > Ready for connection
- > Optical function indicator

Compact high performance fan tray for enforced circulation of air in switch and server enclosures and for concerted cooling of 19" component groups. Natural convection is improved and the formation of localised hot pockets is avoided. Also available with integrated thermostat (see photo).

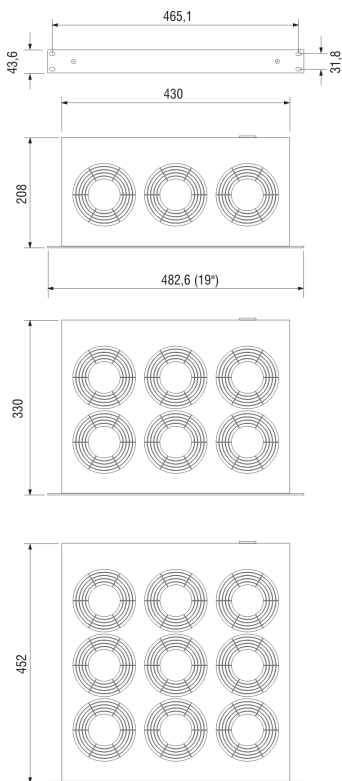

TECHNICAL DATA

Axial fans, ball bearing	service life 50,000 h at +25 °C (+77 °F), 65 % RH
Material	front panel aluminium, bright anodised casing steel sheet, electrogalvanized
Optical indicator	integrated in front panel
Connection	appliance power inlet on rear of casing, plug included
Fitting position	vertical airflow (air outlet up)
Operating/Storage temperature	-10 to +60 °C (+14 to +140 °F) / -40 to +70 °C (-40 to +158 °F)
Operating/Storage humidity	max. 90 % RH (non-condensing)
Protection type/Protection class	IP20 / I (earthed)

Use in 19" enclosures: We recommend using the fan tray without integrated thermostat in combination with our dual thermostat (ZR 011 Art. No. 01176.0-00) for regulating temperature in electronic enclosures and for protection against over-heating due to possible fan failure. The dual thermostat regulates the operation of the fan tray and – when connected to a signal device – also triggers an early warning if the enclosure interior temperature rises above a set limit. When using a fan tray with integrated thermostat, the use of an additional thermostat (KTS 111 Art. No. 11101.0-00) provides the extra safety of activating a signal device.

Art. No.	Thermostat	No. of fans	Operating voltage	Air volume, free flow	Power consumption	Average noise level (DIN EN ISO 4871)	Speed (rpm)	Weight (approx.)	Approvals	
01930.0-00	without	3	AC 230 V, 50 Hz	486 m ³ /h	45 W	55 db (A)	2,600 rpm (50 Hz)	3.0 kg	UL File No. E234324	EAC
01930.1-00	0 to +60 °C	3	AC 230 V, 50 Hz	486 m ³ /h	45 W	55 db (A)	2,600 rpm (50 Hz)	3.4 kg	UL File No. E234324	EAC
01940.0-00	without	6	AC 230 V, 50 Hz	972 m ³ /h	90 W	57 db (A)	2,600 rpm (50 Hz)	5.3 kg	UL File No. E234324	EAC
01940.1-00	0 to +60 °C	6	AC 230 V, 50 Hz	972 m ³ /h	90 W	57 db (A)	2,600 rpm (50 Hz)	5.7 kg	UL File No. E234324	EAC
01950.0-00	without	9	AC 230 V, 50 Hz	1,458 m ³ /h	135 W	58 db (A)	2,600 rpm (50 Hz)	7.8 kg	UL File No. E234324	EAC
01950.1-00	0 to +60 °C	9	AC 230 V, 50 Hz	1,458 m ³ /h	135 W	58 db (A)	2,600 rpm (50 Hz)	7.9 kg	-	EAC
01931.0-00	without	3	AC 120 V, 60 Hz	576 m ³ /h	45 W	55 db (A)	2,900 rpm (60 Hz)	3.0 kg	UL File No. E234324	EAC
01931.1-00	0 to +60 °C	3	AC 120 V, 60 Hz	576 m ³ /h	45 W	55 db (A)	2,900 rpm (60 Hz)	3.4 kg	UL File No. E234324	EAC
01941.0-00	without	6	AC 120 V, 60 Hz	1,152 m ³ /h	90 W	57 db (A)	2,900 rpm (60 Hz)	5.3 kg	UL File No. E234324	EAC
01941.1-00	0 to +60 °C	6	AC 120 V, 60 Hz	1,152 m ³ /h	90 W	57 db (A)	2,900 rpm (60 Hz)	5.7 kg	-	EAC
01951.0-00	without	9	AC 120 V, 60 Hz	1,728 m ³ /h	135 W	58 db (A)	2,900 rpm (60 Hz)	7.8 kg	UL File No. E234324	EAC
01951.1-00	0 to +60 °C	9	AC 120 V, 60 Hz	1,728 m ³ /h	135 W	58 db (A)	2,900 rpm (60 Hz)	7.9 kg	-	EAC